

Dashboard – all 1/16" balsa except motor quadrant in aluminium

CQR Anchors – all .028 steel or brass

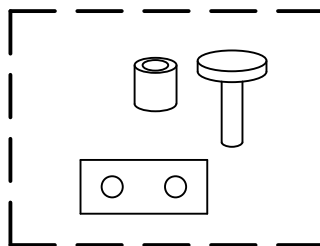

Bow Anchor runner – .01" brass

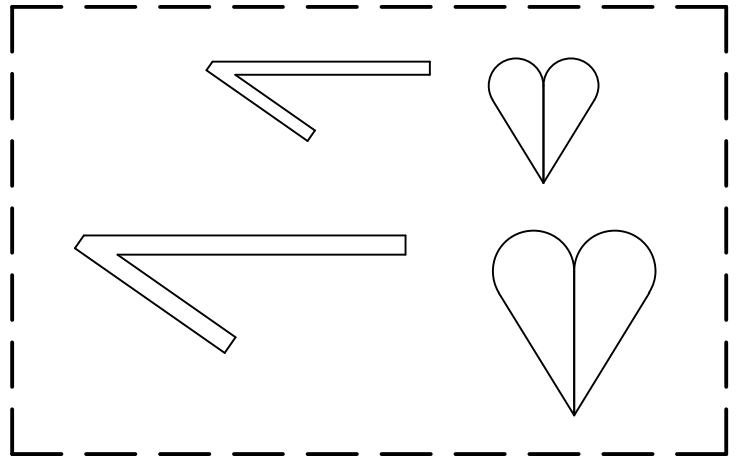
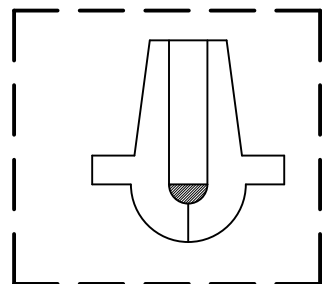

Fairleads – all .01" brass

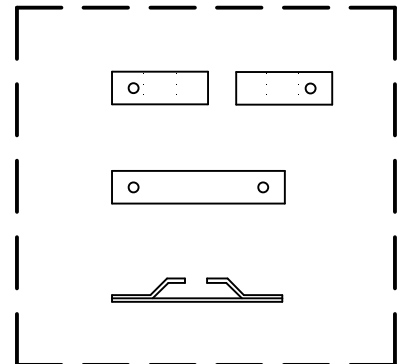

Bollards – .01"brass, a nail head and a bit of brass tube!

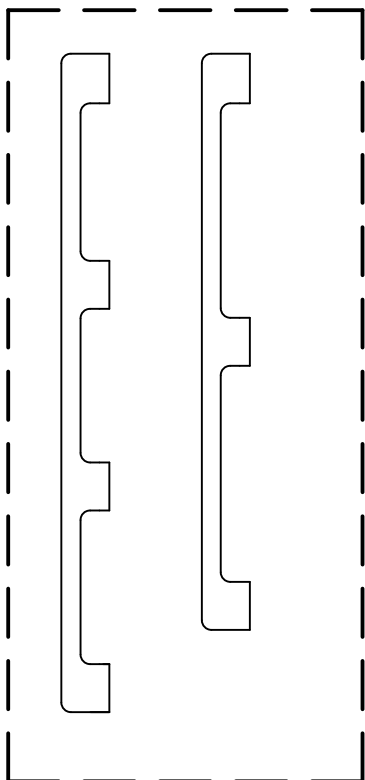

Handrails – all 1/8" balsa

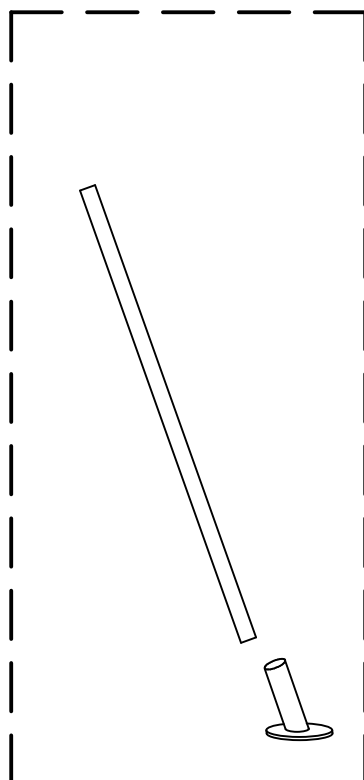

Flagstaff – 3/16" tube in washer

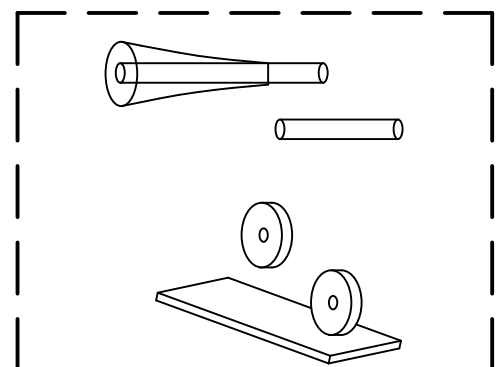

Horn – 1"x1/16 copper wire with filler to make trumpet – solder to 1/4" brass disks and 1"x1/4" brass plate base.

Sea Princess 40

