

Terrier



10 3/4" long EeZeBilt model -

- by Keil Kraft, England, 1958

Full Size Templates to be Printed at A4 size with no scaling
Sheet 1 of 5

TERRIER side skin - originally on panel 4. 1/16" 2 in kit

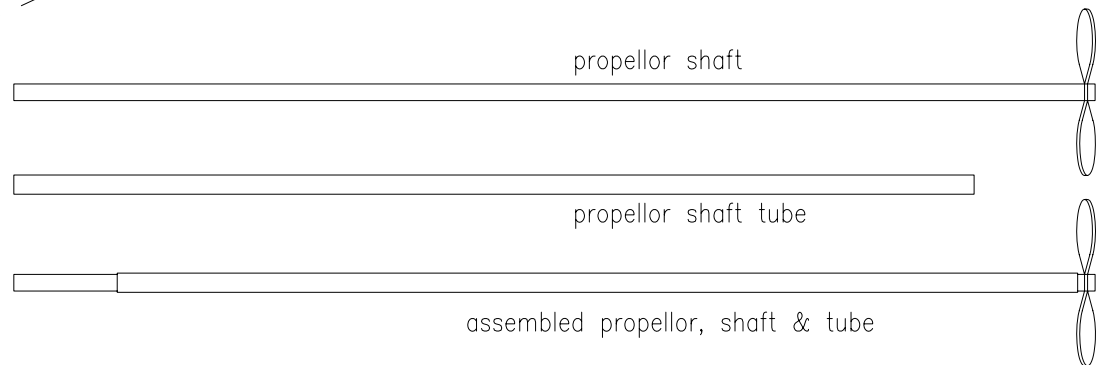
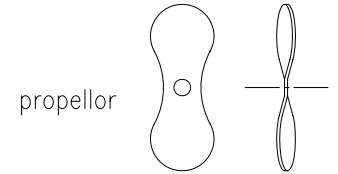
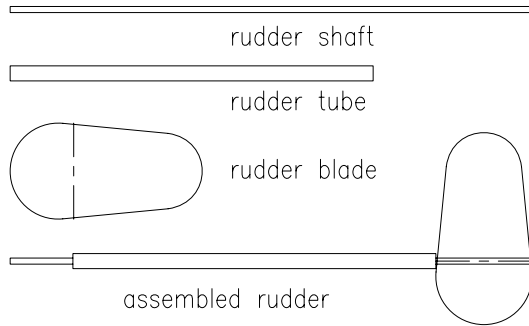

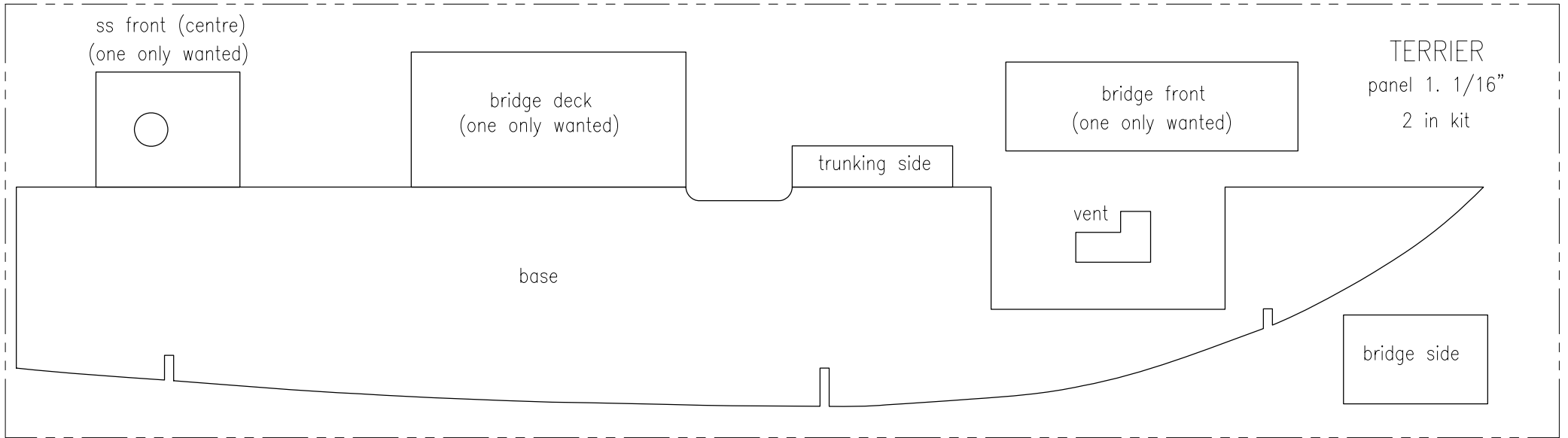

Terrier

10 3/4" long EeZeBilt model -  - by Keil Kraft, England, 1958

Full Size Templates to be Printed at A4 size with no scaling
Sheet 2 of 5

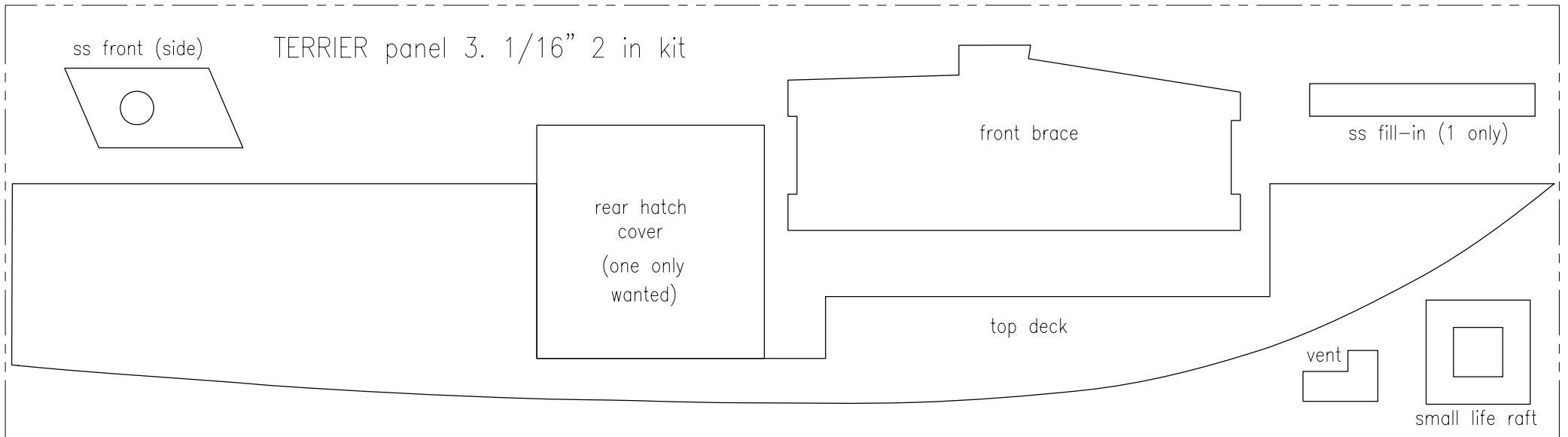

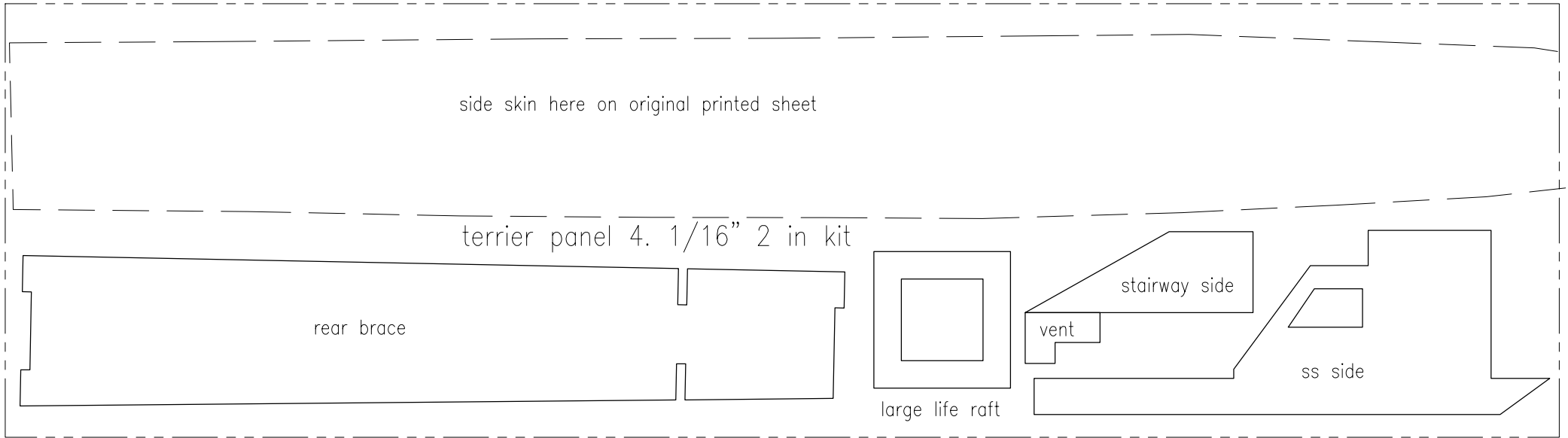

Terrier

10 3/4" long EeZeBilt model -



- by Keil Kraft, England, 1958

Full Size Templates to be Printed at A4 size with no scaling
 Sheet 3 of 5

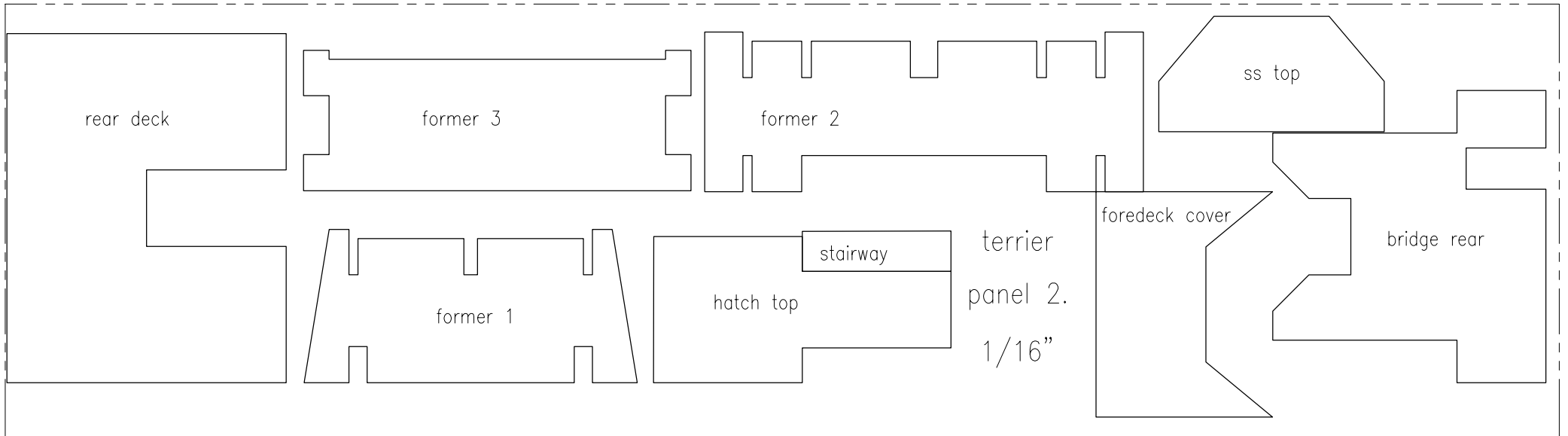



1/4" dia dowel

depth charges

make 4



wire paper clip



radio D.F. loop

make 1



crew

00 scale or 1:72 scale

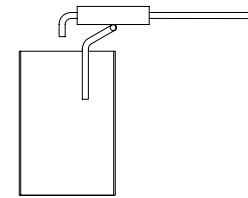

wire paper clip
& paper

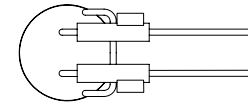

guns & gun mount

make 1

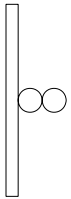

Terrier

10 3/4" long EeZeBilt model -



- by Keil Kraft, England, 1958

Full Size Templates to be Printed at A4 size with no scaling
Sheet 4 of 5

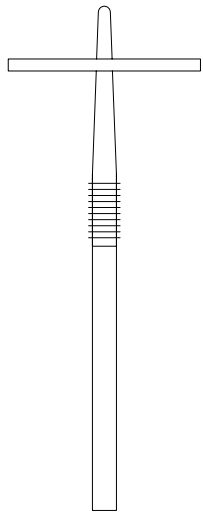

main mast

make 1



bind with thread
and glue

1/8" dia dowel



whip mast

make 1

1/8" dia dowel



paper and thread



torpedo tubes

make 2



TERRIER additional parts recommended. 1/16" not in kit

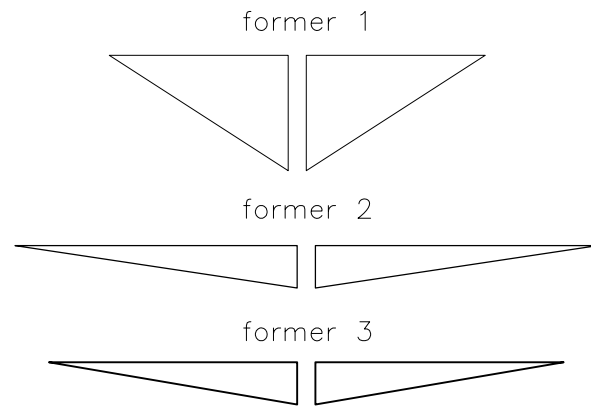

TERRIER additional parts recommended. 3/32" not in kit

treads for stairs

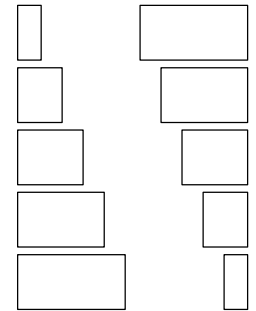

Terrier

10 3/4" long EeZeBilt model -



- by Keil Kraft, England, 1958

Full Size Templates to be Printed at A4 size with no scaling
Sheet 5 of 5

TERRIER original parts recommended not to be used

stairway - 1/16" panel 2



rear outer keel - 3/32" panel 5

rear outer keel - 3/23" panel 5

